

# Dual and Quad Micropower Rail-to-Rail Input and Output Op Amps

## FEATURES

- Rail-to-Rail Input and Output
- Single Supply Input Range: **-0.4V to 44V**
- Micropower: **50 $\mu$ A/Amplifier Max**
- Specified on 3V, 5V and  $\pm$ 15V Supplies
- High Output Current: 20mA
- Output Drives 10,000pF with Output Compensation
- Reverse Battery Protection to 18V
- No Supply Sequencing Problems
- High Voltage Gain: 1500V/mV
- High CMRR: 98dB
- No Phase Reversal
- Gain Bandwidth Product: 200kHz

## APPLICATIONS

- Battery- or Solar-Powered Systems
  - Portable Instrumentation
  - Sensor Conditioning
- Supply Current Sensing
- Battery Monitoring
- Micropower Active Filters
- 4mA to 20mA Transmitters

## DESCRIPTION

The dual LT<sup>®</sup>1490 and quad LT1491 op amps operate on all single and split supplies with a total voltage of 2V to 44V drawing only 40 $\mu$ A of quiescent current per amplifier. These amplifiers are reverse supply protected; they draw no current for reverse supply up to 18V. The input range of the LT1490/LT1491 includes both supplies and the output swings to both supplies. Unlike most micropower op amps, the LT1490/LT1491 can drive heavy loads; their rail-to-rail outputs drive 20mA. The LT1490/LT1491 are unity-gain stable and drive all capacitive loads up to 10,000pF when optional 0.22 $\mu$ F and 150 $\Omega$  compensation is used.

The LT1490/LT1491 have a unique input stage that operates and remains high impedance when above the positive supply. The inputs take 44V both differential and common mode even when operating on a 3V supply. Built-in resistors protect the inputs for faults below the negative supply up to 22V. There is no phase reversal of the output for inputs 22V below  $V^-$  or 44V above  $V^-$ , independent of  $V^+$ .

The LT1490 dual op amp is available in the 8-pin SO and PDIP packages. The quad LT1491 is available in the 14-pin SO and PDIP packages.

 LTC and LT are registered trademarks of Linear Technology Corporation.

## TYPICAL APPLICATION

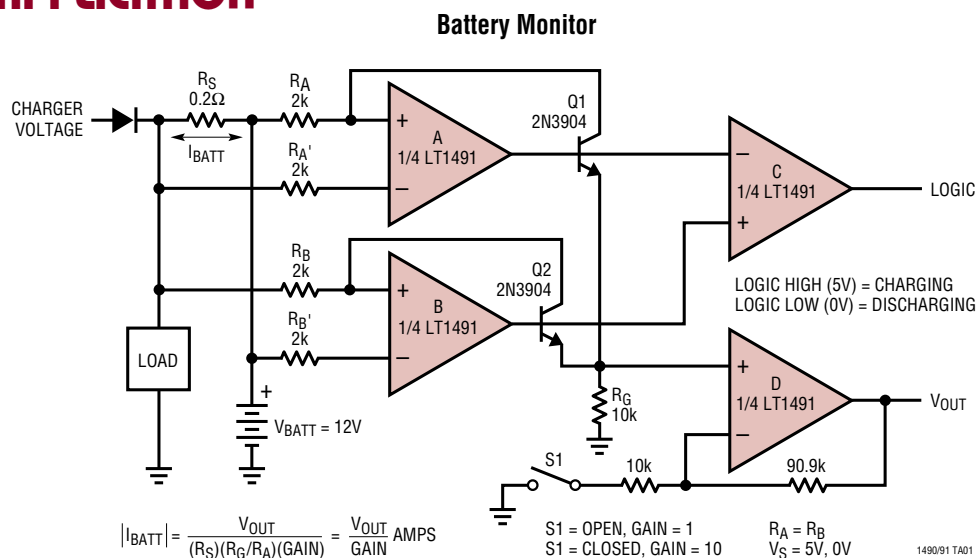

## ABSOLUTE MAXIMUM RATINGS

|   |               |  |                |
|---|---------------|--|----------------|
| Total Supply Voltage ( $V^+$ to $V^-$ ) ..... | 44V           | Junction Temperature .....                 | 150°C          |
| Input Differential Voltage .....              | 44V           | Specified Temperature Range (Note 2) ..    | -40°C to 85°C  |
| Input Current .....                           | ±25mA         | Storage Temperature Range .....            | -65°C to 150°C |
| Output Short-Circuit Duration (Note 1) .....  | Continuous    | Lead Temperature (Soldering, 10 sec) ..... | 300°C          |
| Operating Temperature Range .....             | -40°C to 85°C |  |                |

## PACKAGE/ORDER INFORMATION

|   |                   |   |                      |
|---|-------------------|---|----------------------|
| <p>MS8 PACKAGE<br/>8-LEAD MSOP</p> <p>N8 PACKAGE<br/>8-LEAD PDIP</p> <p>S8 PACKAGE<br/>8-LEAD PLASTIC SO</p> <p><math>T_{JMAX} = 150^\circ\text{C}</math>, <math>\theta_{JA} = 250^\circ\text{C/W}</math> (MS8)<br/> <math>T_{JMAX} = 150^\circ\text{C}</math>, <math>\theta_{JA} = 130^\circ\text{C/W}</math> (N8)<br/> <math>T_{JMAX} = 150^\circ\text{C}</math>, <math>\theta_{JA} = 190^\circ\text{C/W}</math> (S8)</p> | ORDER PART NUMBER | <p>N PACKAGE<br/>14-LEAD PDIP</p> <p>S PACKAGE<br/>14-LEAD PLASTIC SO</p> <p><math>T_{JMAX} = 150^\circ\text{C}</math>, <math>\theta_{JA} = 110^\circ\text{C/W}</math> (N)<br/> <math>T_{JMAX} = 150^\circ\text{C}</math>, <math>\theta_{JA} = 150^\circ\text{C/W}</math> (S)</p> | ORDER PART NUMBER    |
|   | LT1490CMS8        |   | LT1491CN<br>LT1491CS |
|   | LT1490CN8         |   |                      |
|   | LT1490CS8         |   |                      |
|   | MS8 PART MARKING  |   |                      |
| LTBB  | S8 PART MARKING   |   |                      |
| 1490  |                   |   |                      |

Consult factory for Industrial and Military grade parts.

## ELECTRICAL CHARACTERISTICS

$V_S = 3V, 0V$ ;  $V_S = 5V, 0V$ ;  $V_{CM} = V_{OUT} = \text{half supply}$ ,  $T_A = 25^\circ\text{C}$ , unless otherwise noted. (Note 2)

| SYMBOL   | PARAMETER                   | CONDITIONS   | MIN | TYP  | MAX           | UNITS                        |
|----------|-----------------------------|--|-----|------|---------------|------------------------------|
| $V_{OS}$ | Input Offset Voltage        | LT1490 N Package<br>$0^\circ\text{C} \leq T_A \leq 70^\circ\text{C}$<br>$-40^\circ\text{C} \leq T_A \leq 85^\circ\text{C}$                     | ●   | 220  | 800           | $\mu\text{V}$                |
|          |                             |  | ●   |      | 1000          | $\mu\text{V}$                |
|          |                             |  | ●   |      | 1100          | $\mu\text{V}$                |
|          |                             | LT1490 S Package<br>$0^\circ\text{C} \leq T_A \leq 70^\circ\text{C}$<br>$-40^\circ\text{C} \leq T_A \leq 85^\circ\text{C}$                     | ●   | 220  | 950           | $\mu\text{V}$                |
|          |                             | ●  |     | 1200 | $\mu\text{V}$ |                              |
|          |                             | ●  |     | 1300 | $\mu\text{V}$ |                              |
|          | Input Offset Voltage Drift  | LT1491 N Package<br>$0^\circ\text{C} \leq T_A \leq 70^\circ\text{C}$<br>$-40^\circ\text{C} \leq T_A \leq 85^\circ\text{C}$                     | ●   | 300  | 1100          | $\mu\text{V}$                |
|          |                             |  | ●   |      | 1350          | $\mu\text{V}$                |
|          |                             |  | ●   |      | 1450          | $\mu\text{V}$                |
|          |                             | LT1490CMS8 Package, LT1491 S Package<br>$0^\circ\text{C} \leq T_A \leq 70^\circ\text{C}$<br>$-40^\circ\text{C} \leq T_A \leq 85^\circ\text{C}$ | ●   | 350  | 1450          | $\mu\text{V}$                |
|          |                             | ●  |     | 1650 | $\mu\text{V}$ |                              |
|          |                             | ●  |     | 1750 | $\mu\text{V}$ |                              |
|          | Input Offset Voltage Drift  | $0^\circ\text{C} \leq T_A \leq 70^\circ\text{C}$ (Note 6)  | ●   | 2    | 4             | $\mu\text{V}/^\circ\text{C}$ |
| $I_{OS}$ | Input Offset Current        | $V_{CM} = 44V$ (Note 3)  | ●   | 0.2  | 0.8           | nA                           |
|          |                             |  | ●   |      | 0.8           | $\mu\text{A}$                |
| $I_B$    | Input Bias Current          | $V_{CM} = 44V$ (Note 3)  | ●   | 4    | 8             | nA                           |
|          |                             | $V_S = 0V$   | ●   | 4    | 10            | $\mu\text{A}$                |
|          |                             |  | ●   | 0.1  |               | nA                           |
|          | Input Noise Voltage         | 0.1Hz to 10Hz  |     | 1    |               | $\mu\text{V}_{P-P}$          |
| $e_n$    | Input Noise Voltage Density | $f = 1\text{kHz}$  |     | 50   |               | $\text{nV}/\sqrt{\text{Hz}}$ |
| $i_n$    | Input Noise Current Density | $f = 1\text{kHz}$  |     | 0.03 |               | $\text{pA}/\sqrt{\text{Hz}}$ |

## ELECTRICAL CHARACTERISTICS

$V_S = 3V, 0V; V_S = 5V, 0V; V_{CM} = V_{OUT} = \text{half supply}, T_A = 25^\circ C$ , unless otherwise noted. (Note 2)

| SYMBOL    | PARAMETER                             | CONDITIONS                                   | MIN   | TYP   | MAX | UNITS      |
|-----------|---------------------------------------|--|-------|-------|-----|------------|
| $R_{IN}$  | Input Resistance                      | Differential                                 | 6     | 17    |     | $M\Omega$  |
|           |                                       | Common Mode, $V_{CM} = 0V$ to $44V$          | 4     | 11    |     | $M\Omega$  |
| $C_{IN}$  | Input Capacitance                     |  |       | 4.6   |     | pF         |
|           | Input Voltage Range                   | ●  | 0     |       | 44  | V          |
| CMRR      | Common Mode Rejection Ratio (Note 3)  | $V_{CM} = 0V$ to $V_{CC} - 1V$               | 84    | 98    |     | dB         |
|           |                                       | $V_{CM} = 0V$ to $44V$                       | 80    | 98    |     | dB         |
| $A_{VOL}$ | Large-Signal Voltage Gain             | $V_S = 3V, V_O = 500mV$ to $2.5V, R_L = 10k$ | 200   | 1500  |     | V/mV       |
|           |                                       | $0^\circ C \leq T_A \leq 70^\circ C$         | 133   |       |     | V/mV       |
|           |                                       | $-40^\circ C \leq T_A \leq 85^\circ C$       | 100   |       |     | V/mV       |
|           |                                       | $V_S = 5V, V_O = 500mV$ to $4.5V, R_L = 10k$ | 400   | 1500  |     | V/mV       |
| $V_{OL}$  | Output Voltage Swing Low              | $V_S = 3V, \text{No Load}$                   |       | 22    | 50  | mV         |
|           |                                       | $V_S = 3V, I_{SINK} = 5mA$                   |       | 250   | 450 | mV         |
|           |                                       | $V_S = 5V, \text{No Load}$                   |       | 22    | 50  | mV         |
|           |                                       | $V_S = 5V, I_{SINK} = 5mA$                   |       | 250   | 500 | mV         |
| $V_{OH}$  | Output Voltage Swing High             | $V_S = 3V, \text{No Load}$                   | 2.95  | 2.978 |     | V          |
|           |                                       | $V_S = 3V, I_{SOURCE} = 5mA$                 | 2.55  | 2.6   |     | V          |
|           |                                       | $V_S = 5V, \text{No Load}$                   | 4.95  | 4.978 |     | V          |
|           |                                       | $V_S = 5V, I_{SOURCE} = 10mA$                | 4.30  | 4.6   |     | V          |
| $I_{SC}$  | Short-Circuit Current (Note 1)        | $V_S = 3V, \text{Short to GND}$              | 10    | 15    |     | mA         |
|           |                                       | $V_S = 3V, \text{Short to } V_{CC}$          | 10    | 30    |     | mA         |
|           |                                       | $V_S = 5V, \text{Short to GND}$              | 15    | 25    |     | mA         |
|           |                                       | $V_S = 5V, \text{Short to } V_{CC}$          | 15    | 30    |     | mA         |
| PSRR      | Power Supply Rejection Ratio          | $V_S = 2.5V$ to $12.5V, V_{CM} = V_O = 1V$   | 84    | 98    |     | dB         |
|           | Minimum Operating Supply Voltage      | ●  |       | 2     | 2.5 | V          |
|           | Reverse Supply Voltage                | ●  | 18    | 27    |     | V          |
| $I_S$     | Supply Current per Amplifier (Note 4) | ●  |       | 40    | 50  | $\mu A$    |
|           |                                       | ●  |       |       | 55  | $\mu A$    |
| GBW       | Gain Bandwidth Product (Note 3)       | $f = 1kHz$                                   | 110   | 180   |     | kHz        |
|           |                                       | $0^\circ C \leq T_A \leq 70^\circ C$         | 100   |       |     | kHz        |
|           |                                       | $-40^\circ C \leq T_A \leq 85^\circ C$       | 90    |       |     | kHz        |
| SR        | Slew Rate (Note 5)                    | $A_V = -1, R_L = \infty$                     | 0.035 | 0.06  |     | V/ $\mu s$ |
|           |                                       | $0^\circ C \leq T_A \leq 70^\circ C$         | 0.031 |       |     | V/ $\mu s$ |
|           |                                       | $-40^\circ C \leq T_A \leq 85^\circ C$       | 0.030 |       |     | V/ $\mu s$ |

$V_S = \pm 15V, V_{CM} = 0V, V_{OUT} = 0V, T_A = 25^\circ C$ , unless otherwise noted. (Note 2)

| SYMBOL   | PARAMETER            | CONDITIONS                             | MIN | TYP | MAX  | UNITS   |
|----------|----------------------|--|-----|-----|------|---------|
| $V_{OS}$ | Input Offset Voltage | LT1490 N, S Package                    |     | 250 | 1200 | $\mu V$ |
|          |                      | $0^\circ C \leq T_A \leq 70^\circ C$   | ●   |     | 1400 | $\mu V$ |
|          |                      | $-40^\circ C \leq T_A \leq 85^\circ C$ | ●   |     | 1500 | $\mu V$ |
|          |                      | LT1491 N Package                       |     | 350 | 1250 | $\mu V$ |
|          |                      | $0^\circ C \leq T_A \leq 70^\circ C$   | ●   |     | 1500 | $\mu V$ |
|          |                      | $-40^\circ C \leq T_A \leq 85^\circ C$ | ●   |     | 1600 | $\mu V$ |
|          |                      | LT1490CMS8 Package, LT1491 S Package   |     | 400 | 1600 | $\mu V$ |
|          |                      | $0^\circ C \leq T_A \leq 70^\circ C$   | ●   |     | 1850 | $\mu V$ |
|          |                      | $-40^\circ C \leq T_A \leq 85^\circ C$ | ●   |     | 1950 | $\mu V$ |

## ELECTRICAL CHARACTERISTICS

$V_S = \pm 15V$ ,  $V_{CM} = 0V$ ,  $V_{OUT} = 0V$ ,  $T_A = 25^\circ C$ , unless otherwise noted. (Note 2)

| SYMBOL    | PARAMETER                      | CONDITIONS   | MIN         | TYP                                    | MAX  | UNITS                               |
|-----------|--------------------------------|--|-------------|--|--|-------------------------------------|
|           | Input Offset Voltage Drift     | $0^\circ C \leq T_A \leq 70^\circ C$ (Note 6)  | ●           | 3                                      | 6  | $\mu V/^\circ C$                    |
| $I_{OS}$  | Input Offset Current           |  | ●           | 0.2                                    | 0.8  | nA                                  |
| $I_B$     | Input Bias Current             |  | ●           | 4                                      | 8  | nA                                  |
|           | Input Noise Voltage            | 0.1Hz to 10Hz  |             | 1                                      |  | $\mu V_{P-P}$                       |
| $e_n$     | Input Noise Voltage Density    | $f = 1kHz$   |             | 50                                     |  | $nV/\sqrt{Hz}$                      |
| $i_n$     | Input Noise Current Density    | $f = 1kHz$   |             | 0.03                                   |  | $pA/\sqrt{Hz}$                      |
| $R_{IN}$  | Input Resistance               | Differential<br>Common Mode, $V_{CM} = -15V$ to $14V$  |             | 6<br>17<br>15000                       |  | $M\Omega$<br>$M\Omega$              |
| $C_{IN}$  | Input Capacitance              |  |             | 4.6                                    |  | pF                                  |
|           | Input Voltage Range            |  | ●           | -15                                    | 29   | V                                   |
| CMRR      | Common Mode Rejection Ratio    | $V_{CM} = -15V$ to $29V$   | ●           | 80                                     | 98   | dB                                  |
| $A_{VOL}$ | Large-Signal Voltage Gain      | $V_O = \pm 14V$ , $R_L = 10k$<br>$0^\circ C \leq T_A \leq 70^\circ C$<br>$-40^\circ C \leq T_A \leq 85^\circ C$  | ●<br>●<br>● | 100<br>75<br>50                        | 250  | $V/mV$<br>$V/mV$<br>$V/mV$          |
| $V_O$     | Output Voltage Swing           | No Load<br>$I_{OUT} = \pm 5mA$<br>$I_{OUT} = \pm 10mA$   | ●<br>●<br>● | $\pm 14.9$<br>$\pm 14.5$<br>$\pm 14.5$ | $\pm 14.978$<br>$\pm 14.750$<br>$\pm 14.670$ | V<br>V<br>V                         |
| $I_{SC}$  | Short-Circuit Current (Note 1) | Short to GND<br>$0^\circ C \leq T_A \leq 70^\circ C$<br>$-40^\circ C \leq T_A \leq 85^\circ C$   | ●<br>●      | $\pm 20$<br>$\pm 15$<br>$\pm 10$       | $\pm 25$                                     | mA<br>mA<br>mA                      |
| PSRR      | Power Supply Rejection Ratio   | $V_S = \pm 1.25V$ to $\pm 22V$   | ●           | 88                                     | 98   | dB                                  |
| $I_S$     | Supply Current per Amplifier   |  | ●           | 50                                     | 70<br>85                                     | $\mu A$<br>$\mu A$                  |
| GBW       | Gain Bandwidth Product         | $f = 1kHz$<br>$0^\circ C \leq T_A \leq 70^\circ C$<br>$-40^\circ C \leq T_A \leq 85^\circ C$   | ●<br>●      | 125<br>110<br>100                      | 200  | kHz<br>kHz<br>kHz                   |
| SR        | Slew Rate                      | $A_V = -1$ , $R_L = \infty$ , $V_O = \pm 10V$ ,<br>Measure at $V_O = \pm 5V$<br>$0^\circ C \leq T_A \leq 70^\circ C$<br>$-40^\circ C \leq T_A \leq 85^\circ C$ | ●<br>●      | 0.0375<br>0.0330<br>0.0300             | 0.07   | $V/\mu s$<br>$V/\mu s$<br>$V/\mu s$ |

The ● denotes specifications which apply over the full operating temperature range.

**Note 1:** A heat sink may be required to keep the junction temperature below absolute maximum. This depends on the power supply voltage and how many amplifiers are shorted.

**Note 2:** The LT1490/LT1491 are designed, characterized and expected to meet these extended temperature limits, but are not tested at  $-40^\circ C$  and  $85^\circ C$ . Guaranteed I grade parts are available, consult factory.

**Note 3:**  $V_S = 5V$  limits are guaranteed by correlation to  $V_S = 3V$  and  $V_S = \pm 15V$  tests.

**Note 4:**  $V_S = 3V$  limits are guaranteed by correlation to  $V_S = 5V$  and  $V_S = \pm 15V$  tests.

**Note 5:** Guaranteed by correlation to slew rate at  $V_S = \pm 15V$  and GBW at  $V_S = 3V$  and  $V_S = \pm 15V$  tests.

**Note 6:** This parameter is not 100% tested.

# TYPICAL PERFORMANCE CHARACTERISTICS

**Supply Current vs Supply Voltage**

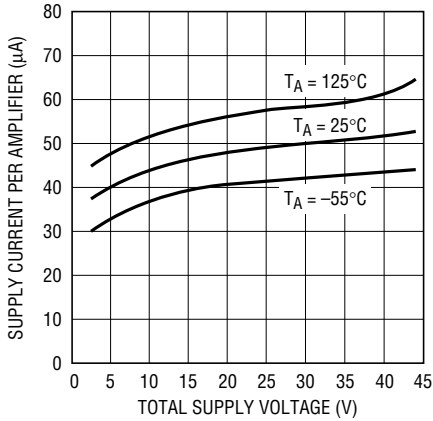

1490/91 G01

**Minimum Supply Voltage**

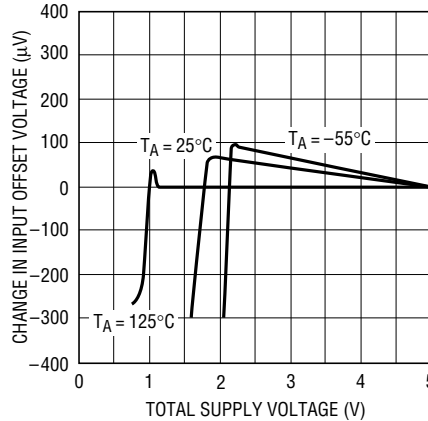

1490/91 G02

**Input Bias Current vs Common Mode Voltage**

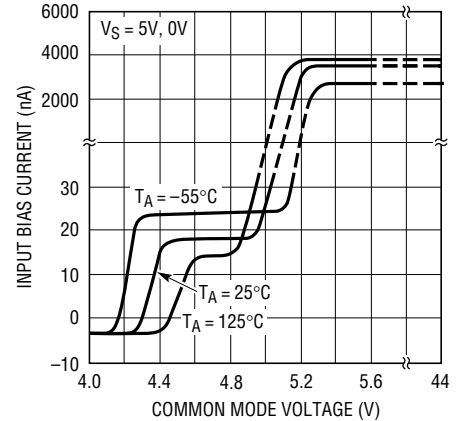

1490/91 G03

**Output Saturation Voltage vs Load Current (Output High)**

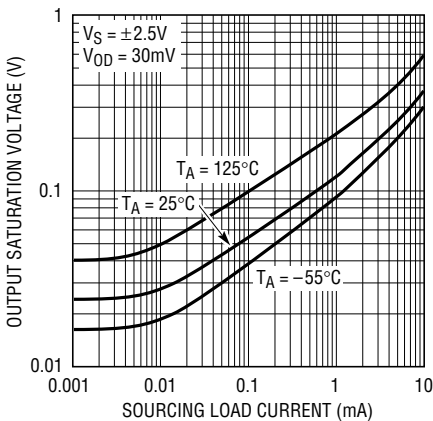

1490/90 G04

**Output Saturation Voltage vs Load Current (Output Low)**

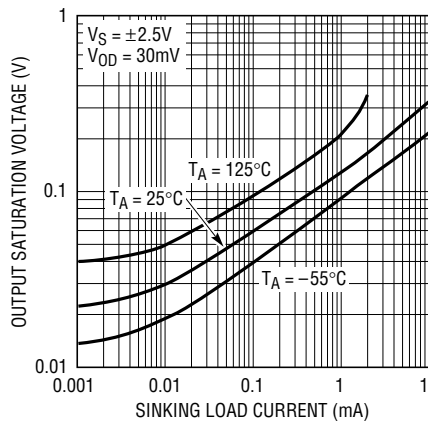

1490/90 G05

**Output Saturation Voltage vs Input Overdrive**

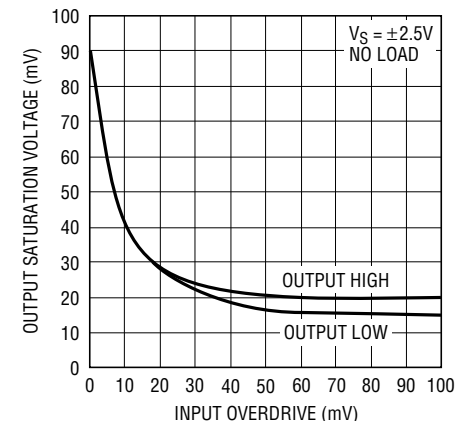

1490/91 G06

**0.1Hz to 10Hz Noise Voltage**

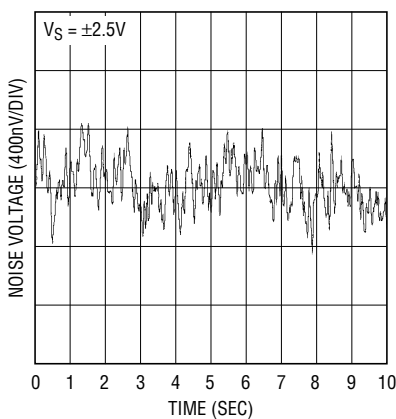

1490 G07

**Noise Voltage Density vs Frequency**

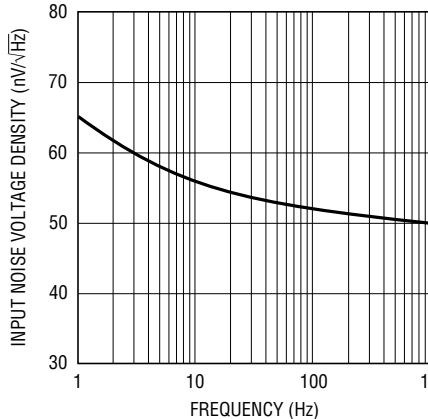

1490/91 G08

**Input Noise Current vs Frequency**

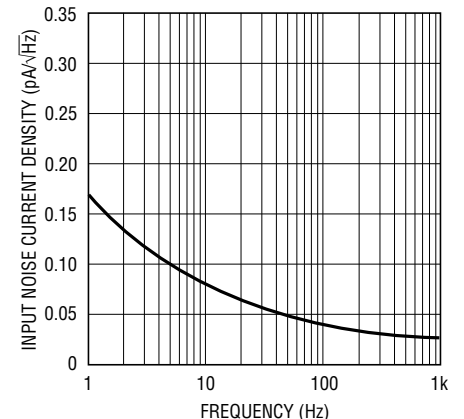

1490/91 G09

# TYPICAL PERFORMANCE CHARACTERISTICS

**Gain and Phase Shift vs Frequency**

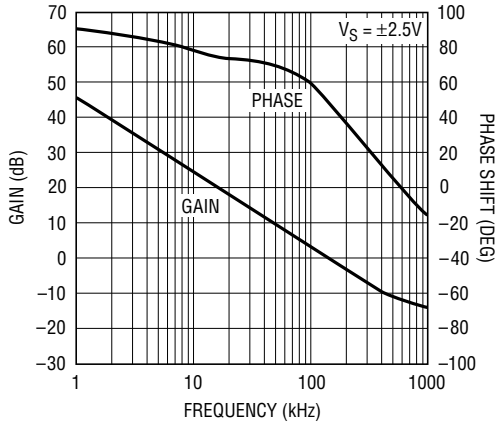

1490/91 G10

**Gain Bandwidth Product vs Temperature**

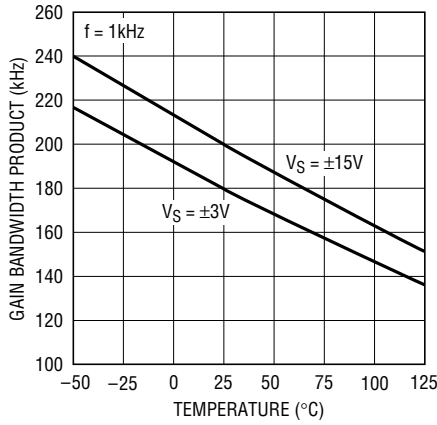

1490/91 G11

**Slew Rate vs Temperature**

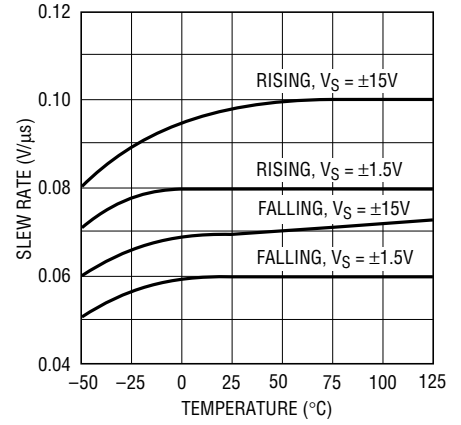

1490/91 G12

**Gain Bandwidth Product and Phase Margin vs Supply Voltage**

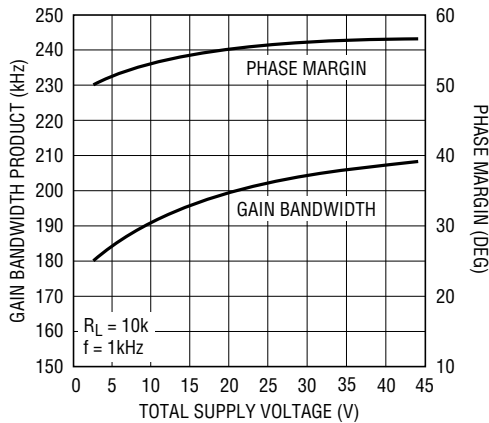

1490/91 G13

**CMRR vs Frequency**

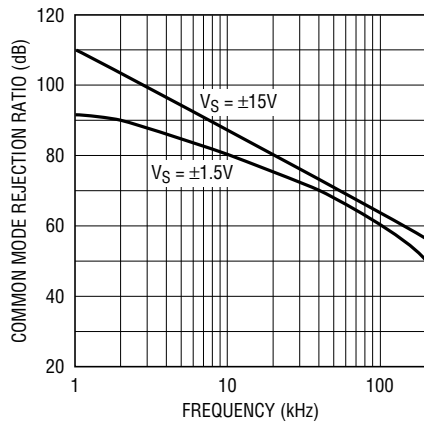

1490 G14

**PSRR vs Frequency**

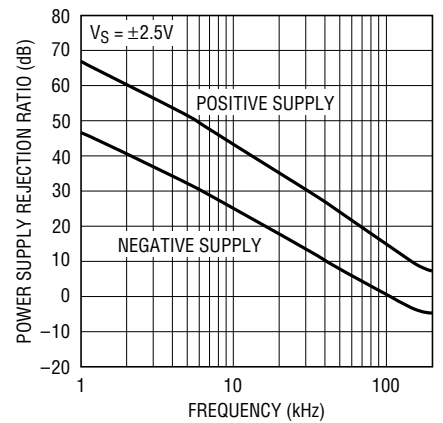

1490/91 G15

**Gain Bandwidth Product and Phase Margin vs Load Resistance**

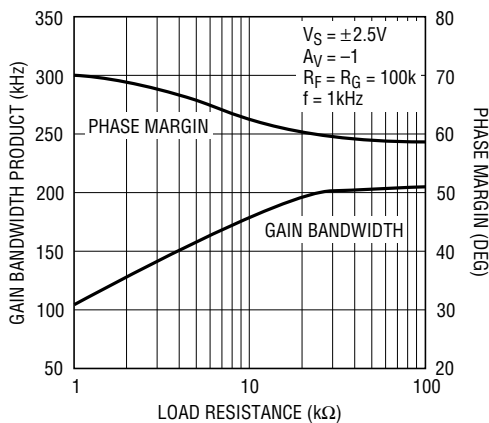

1490/91 G16

**Channel Separation vs Frequency**

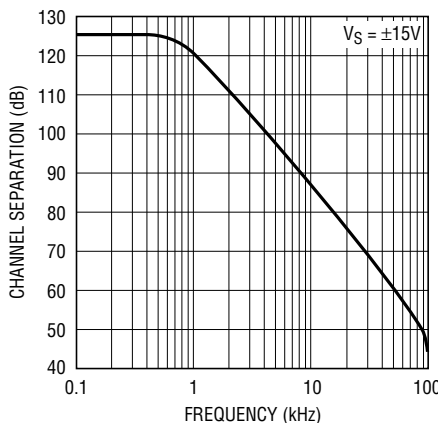

1490/91 G17

**Output Impedance vs Frequency**

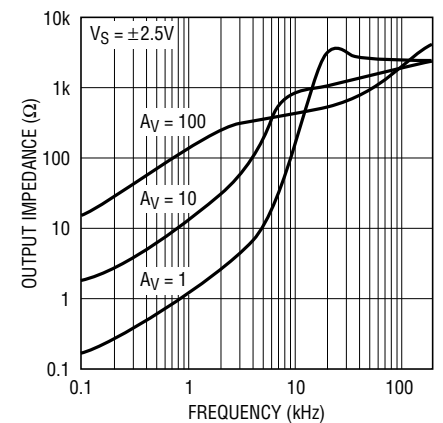

1490/91 G18

# TYPICAL PERFORMANCE CHARACTERISTICS

**Undistorted Output Swing vs Frequency**

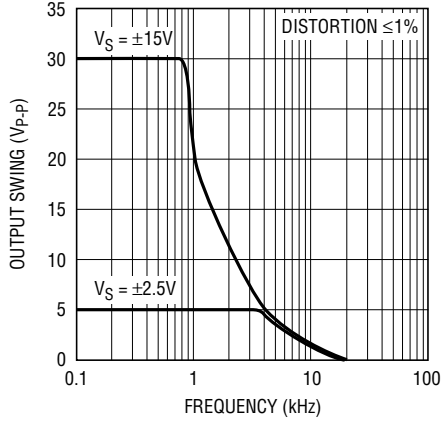

1490/91 G19

**Settling Time to 0.1% vs Output Step**

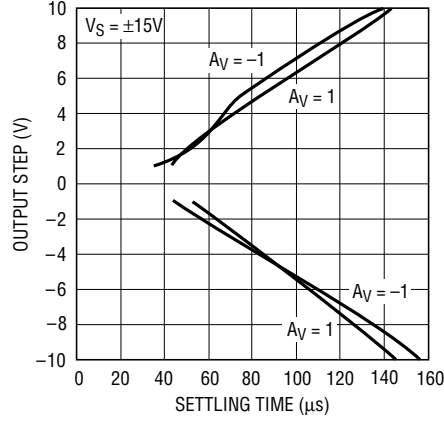

1490/91 F20

**Capacitive Load Handling, Overshoot vs Capacitive Load**

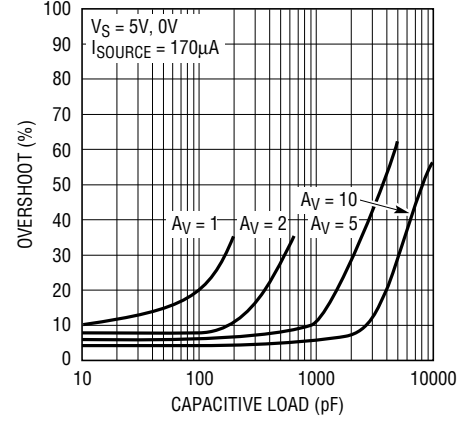

1490/91 G21

**Total Harmonic Distortion + Noise vs Frequency**

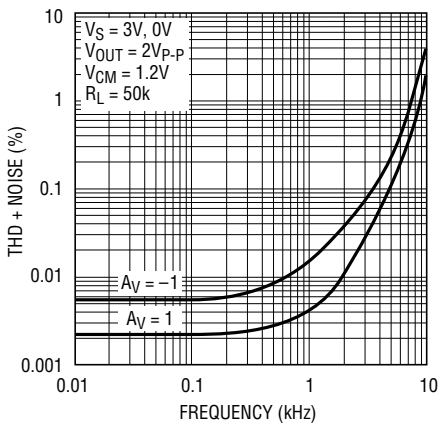

1490/91 G22

**Total Harmonic Distortion + Noise vs Load Resistance**

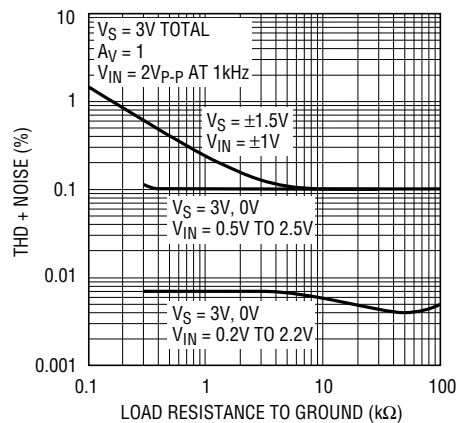

1490/91 G23

**Total Harmonic Distortion + Noise vs Output Voltage**

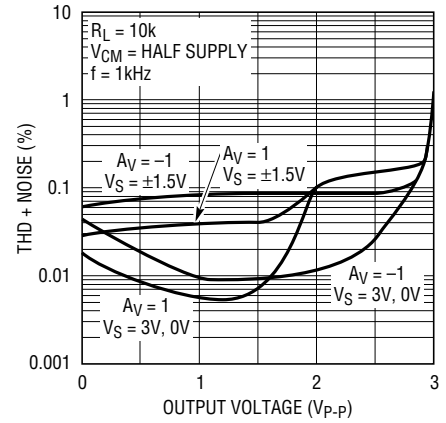

1490/91 G24

**Open-Loop Gain**

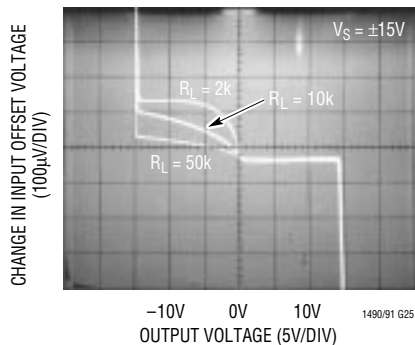

1490/91 G25

**Large-Signal Response**

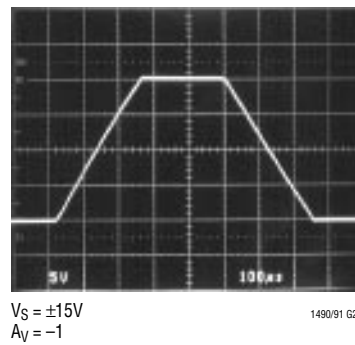

1490/91 G26

**Small-Signal Response**

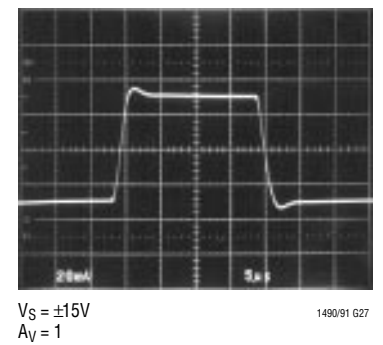

1490/91 G27

## APPLICATIONS INFORMATION

### Supply Voltage

The positive supply pin of the LT1490/LT1491 should be bypassed with a small capacitor (about 0.01 $\mu$ F) within an inch of the pin. When driving heavy loads an additional 4.7 $\mu$ F electrolytic capacitor should be used. When using split supplies, the same is true for the negative supply pin.

The LT1490/LT1491 are protected against reverse battery voltages up to 18V. In the event a reverse battery condition occurs, the supply current is less than 1nA.

The LT1490/LT1491 can be shut down by removing  $V^+$ . In this condition the input bias current is less than 0.1nA, even if the inputs are 44V above the negative supply.

When operating the LT1490/LT1491 on total supplies of 30V or more, the supply must not be brought up faster than 1 $\mu$ s. This is especially true if low ESR bypass capacitors are used. A series RLC circuit is formed from the supply lead inductance and the bypass capacitor. 5 $\Omega$  of resistance in the supply or the bypass capacitor will dampen the tuned circuit enough to limit the rise time.

### Inputs

The LT1490/LT1491 have two input stages, NPN and PNP (see the Simplified Schematic), resulting in three distinct operating regions as shown in the Input Bias Current vs Common Mode typical performance curve.

For input voltages about 0.8V or more below  $V^+$ , the PNP input stage is active and the input bias current is typically -4nA. When the input voltage is about 0.5V or less from  $V^+$ , the NPN input stage is operating and the input bias current is typically 18nA. Increases in temperature will cause the voltage at which operation switches from the PNP stage to the NPN stage to move towards  $V^+$ . The input offset voltage of the NPN stage is untrimmed and is typically 600 $\mu$ V.

A Schottky diode in the collector of each NPN transistor of the NPN input stage allows the LT1490/LT1491 to operate with either or both of its inputs above  $V^+$ . At about 0.3V above  $V^+$  the NPN input transistor is fully saturated and the input bias current is typically 4 $\mu$ A at room temperature. The input offset voltage is typically 700 $\mu$ V when operating above  $V^+$ . The LT1490/LT1491 will operate with its inputs 44V above  $V^-$  regardless of  $V^+$ .

The inputs are protected against excursions as much as 22V below  $V^-$  by an internal 1k resistor in series with each input and a diode from the input to the negative supply. There is no output phase reversal for inputs up to 22V below  $V^-$ . There are no clamping diodes between the inputs and the maximum differential input voltage is 44V.

### Output

The output voltage swing of the LT1490/LT1491 is affected by input overdrive as shown in the typical performance curves. When monitoring voltages within 100mV of either rail, gain should be taken to keep the output from clipping.

The output of the LT1490/LT1491 can be pulled up to 18V beyond  $V^+$  with less than 1nA of leakage current, provided that  $V^+$  is less than 0.5V.

The normally reverse-biased substrate diode from the output to  $V^-$  will cause unlimited currents to flow when the output is forced below  $V^-$ . If the current is transient and limited to 100mA, no damage will occur.

The LT1490/LT1491 is internally compensated to drive at least 200pF of capacitance under any output loading conditions. A 0.22 $\mu$ F capacitor in series with a 150 $\Omega$  resistor between the output and ground will compensate these amplifiers for larger capacitive loads, up to 10,000pF, at all output currents.

### Distortion

There are two main contributors of distortion in op amps: output crossover distortion as the output transitions from sourcing to sinking current and distortion caused by nonlinear common mode rejection. Of course, if the op amp is operating inverting there is no common mode induced distortion. When the LT1490 switches between input stages there is significant nonlinearity in the CMRR. Lower load resistance increases the output crossover distortion, but has no effect on the input stage transition distortion. For lowest distortion the LT1490/LT1491 should be operated single supply, with the output always sourcing current and with the input voltage swing between ground and ( $V^+ - 0.8V$ ). See the Typical Performance Characteristics curves.



## APPLICATIONS INFORMATION

### Gain

The open-loop gain is almost independent of load when the output is sourcing current. This optimizes perfor-

mance in single supply applications where the load is returned to ground. The typical performance photo of Open-Loop Gain for various loads shows the details.

## TYPICAL APPLICATIONS

Square Wave Oscillator

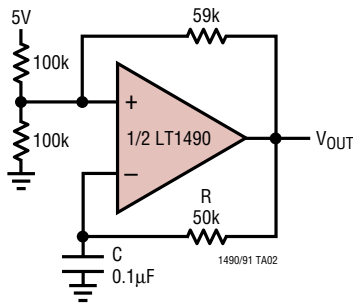

$$f = \frac{1}{2RC}$$

$V_{OUT} = 5V_{P-P}$  WITH 5V SUPPLY

$I_S = 200\mu A$

AT  $V_S = 5V$ ,  $R = 50k$ ,  $C = 1nF$   
OUTPUT IS 5kHz SLEW LIMITED TRIANGLE WAVE

Optional Output Compensation for Capacitive Loads Greater Than 200pF

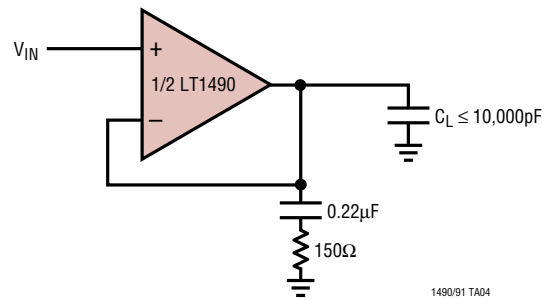

## SIMPLIFIED SCHEMATIC

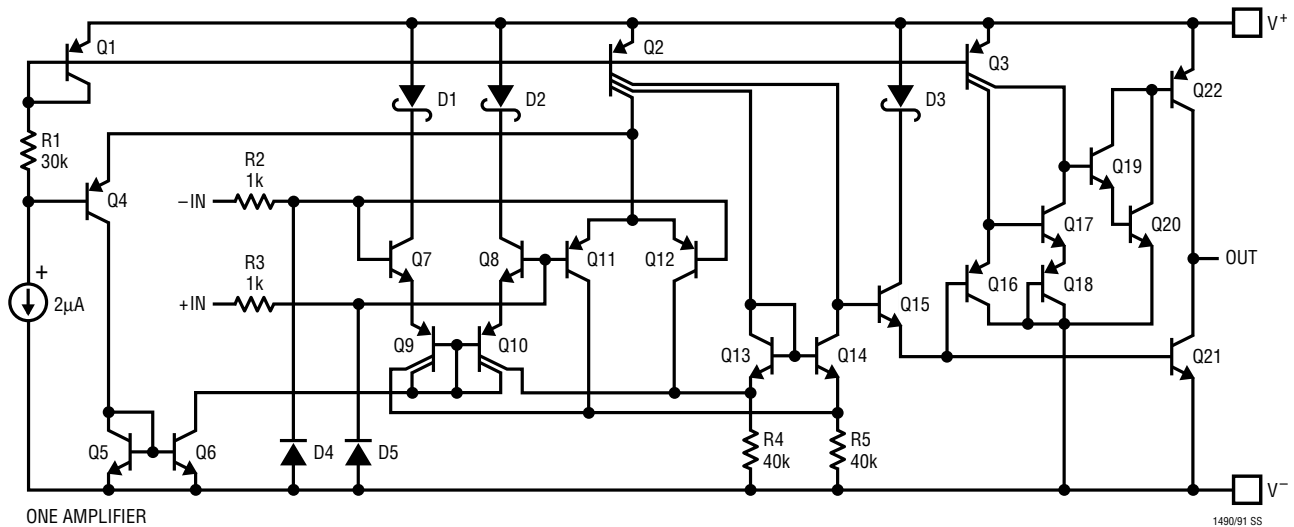

**PACKAGE DESCRIPTION** Dimensions in inches (millimeters) unless otherwise noted.

**MS Package**  
**8-Lead Plastic MSOP**  
 (LTC DWG # 05-08-1660)

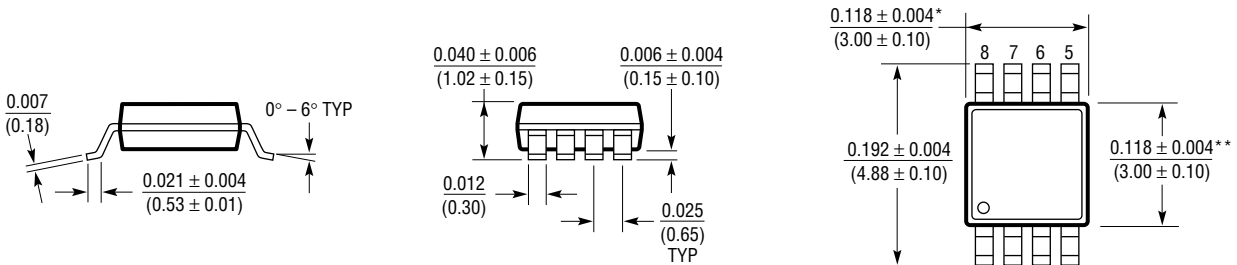

\* DIMENSION DOES NOT INCLUDE MOLD FLASH, PROTRUSIONS OR GATE BURRS. MOLD FLASH, PROTRUSIONS OR GATE BURRS SHALL NOT EXCEED 0.006" (0.152mm) PER SIDE

\*\* DIMENSION DOES NOT INCLUDE INTERLEAD FLASH OR PROTRUSIONS. INTERLEAD FLASH OR PROTRUSIONS SHALL NOT EXCEED 0.006" (0.152mm) PER SIDE

**N8 Package**  
**8-Lead PDIP (Narrow 0.300)**  
 (LTC DWG # 05-08-1510)

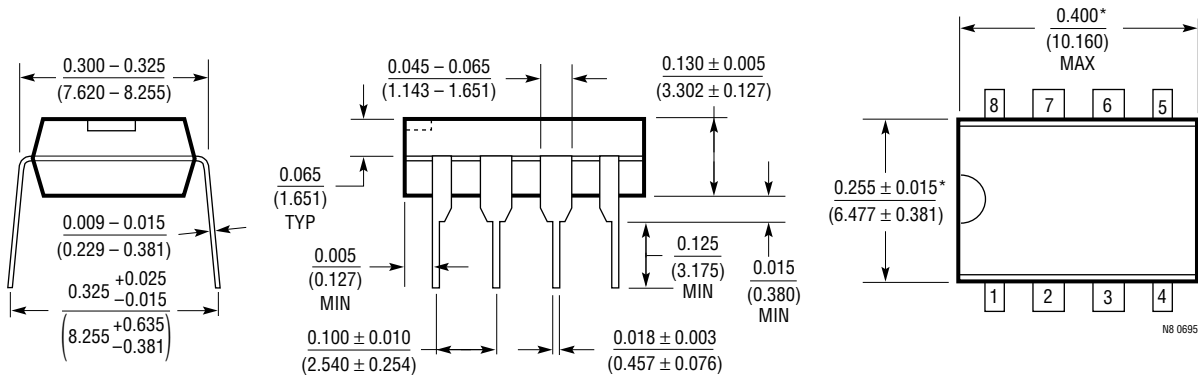

\*THESE DIMENSIONS DO NOT INCLUDE MOLD FLASH OR PROTRUSIONS. MOLD FLASH OR PROTRUSIONS SHALL NOT EXCEED 0.010 INCH (0.254mm)

**S8 Package**  
**8-Lead Plastic Small Outline (Narrow 0.150)**  
 (LTC DWG # 05-08-1610)

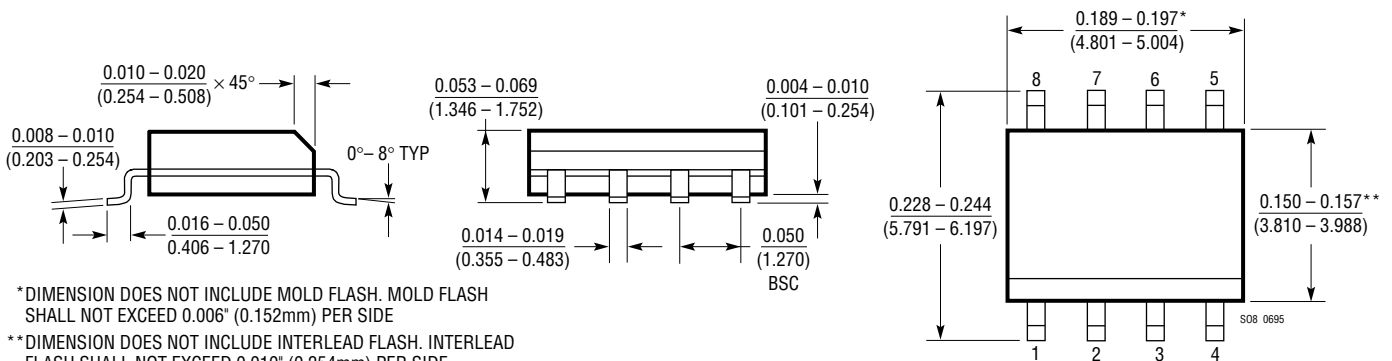

\* DIMENSION DOES NOT INCLUDE MOLD FLASH. MOLD FLASH SHALL NOT EXCEED 0.006" (0.152mm) PER SIDE

\*\* DIMENSION DOES NOT INCLUDE INTERLEAD FLASH. INTERLEAD FLASH SHALL NOT EXCEED 0.010" (0.254mm) PER SIDE

**PACKAGE DESCRIPTION** Dimensions in inches (millimeters) unless otherwise noted.

**N Package**  
**14-Lead PDIP (Narrow 0.300)**  
 (LTC DWG # 05-08-1510)

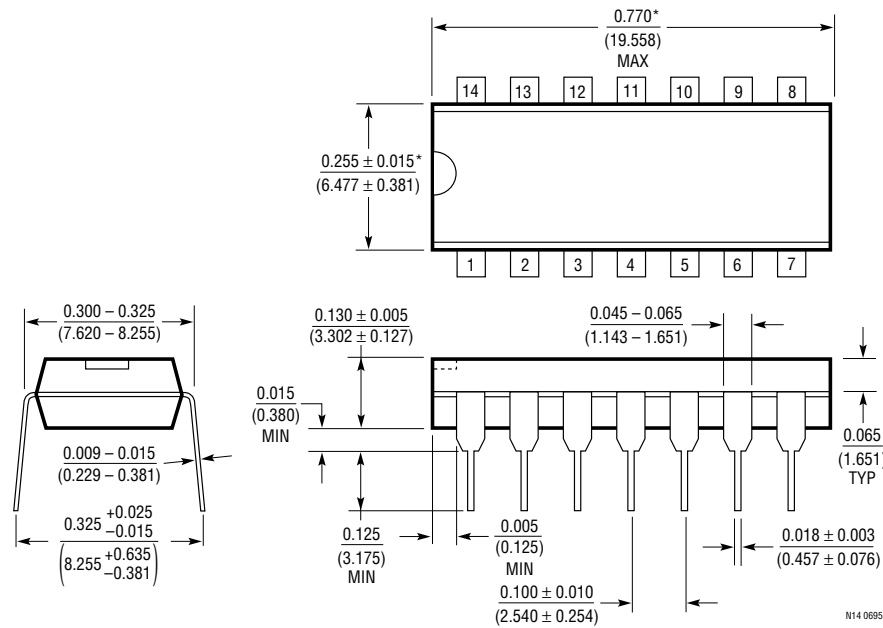

\*THESE DIMENSIONS DO NOT INCLUDE MOLD FLASH OR PROTRUSIONS.  
 MOLD FLASH OR PROTRUSIONS SHALL NOT EXCEED 0.010 INCH (0.254mm)

**S Package**  
**14-Lead Plastic Small Outline (Narrow 0.150)**  
 (LTC DWG # 05-08-1610)

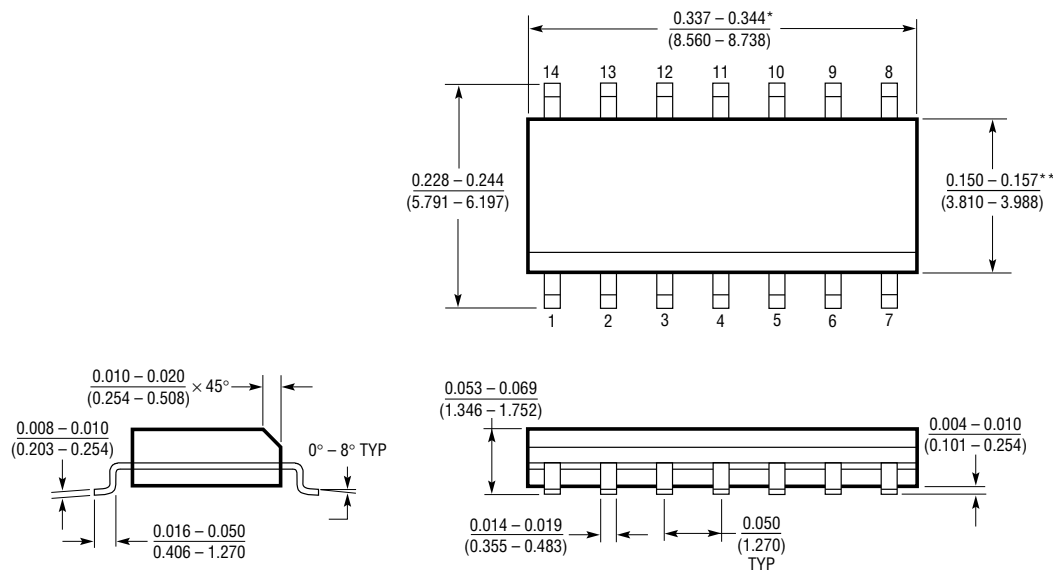

\*DIMENSION DOES NOT INCLUDE MOLD FLASH. MOLD FLASH SHALL NOT EXCEED 0.006" (0.152mm) PER SIDE  
 \*\*DIMENSION DOES NOT INCLUDE INTERLEAD FLASH. INTERLEAD FLASH SHALL NOT EXCEED 0.010" (0.254mm) PER SIDE

**TYPICAL APPLICATION**

**Ring-Tone Generator**

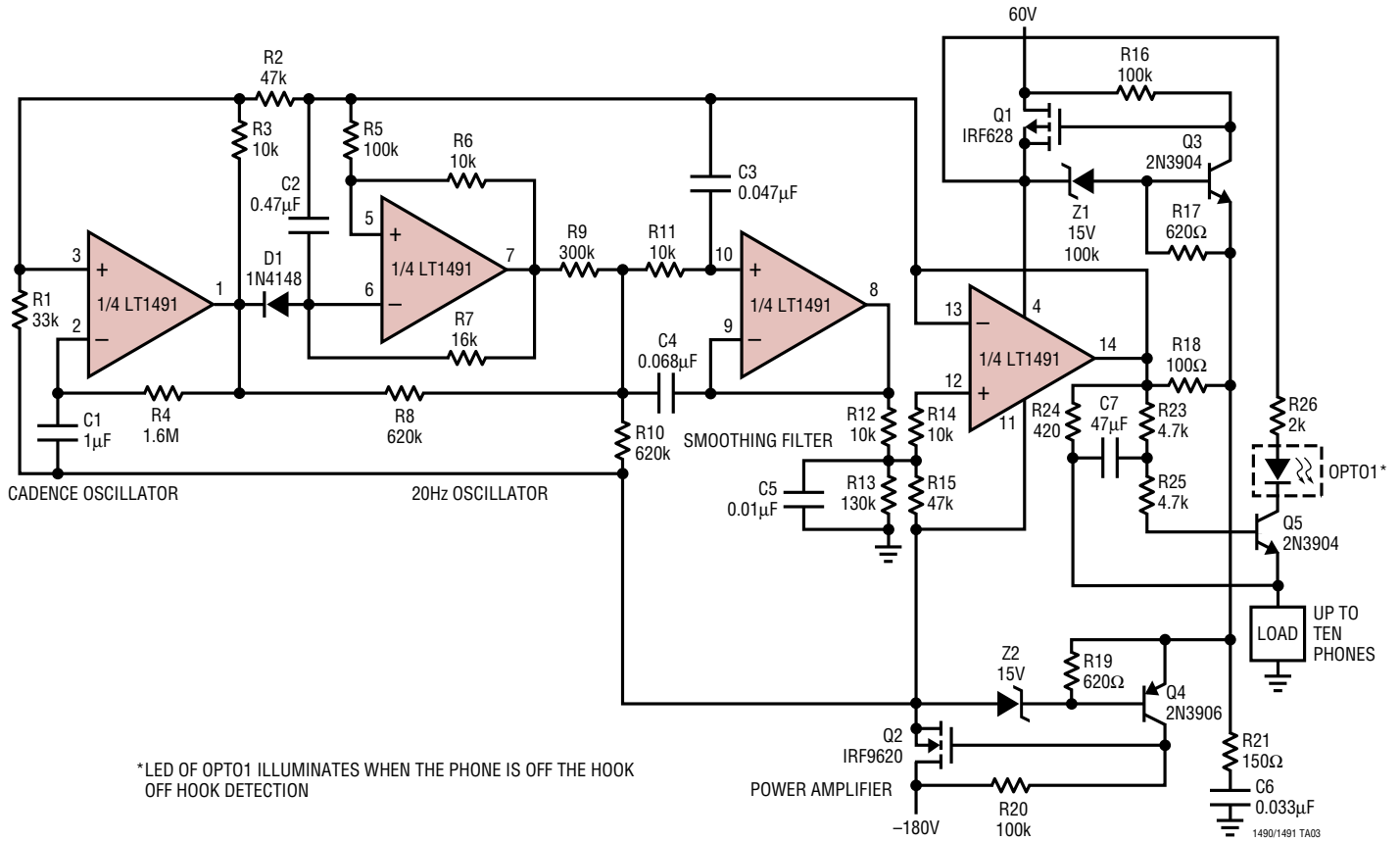

**RELATED PARTS**

| PART NUMBER   | DESCRIPTION   | COMMENTS  |
|---------------|---|---|
| LT1078/LT1079 | Dual/Quad 55μA Max, Single Supply, Precision Op Amps          | Input/Output Common Mode Includes Ground, 70μV V <sub>OS(MAX)</sub> and 2.5μV/°C Drift (Max), 200kHz GBW, 0.07V/μs Slew Rate  |
| LTC1152       | Rail-to-Rail Input, Rail-to-Rail Output, Zero-Drift Amplifier | High DC Accuracy, 10μV V <sub>OS(MAX)</sub> , 100nV/°C, 1MHz GBW, 1V/μs Slew Rate, Supply Current 2.2mA (Max), Single Supply, Can Be Configured for C-Load™ Operation |
| LT1178/LT1179 | Dual/Quad 17μA Max, Single Supply, Precision Op Amps          | Input/Output Common Mode Includes Ground, 70μV V <sub>OS(MAX)</sub> and 4μV/°C Drift (Max), 85kHz GBW, 0.04V/μs Slew Rate   |
| LT1366/LT1367 | Dual/Quad Precision, Rail-to-Rail Input and Output Op Amps    | 475μV V <sub>OS(MAX)</sub> , 500V/mV A <sub>VOL(MIN)</sub> , 400kHz GBW   |

C-Load is a trademark of Linear Technology Corporation.